



infiniti

XØSSCOLLECTION



infiniti

LAVABO E BIDET *BASIN AND BIDET* LAVABO ET BIDET

size **R**



IF 44M177 CR

monocomando lavabo con portasapone, scarico 1 1/4"
single-lever basin mixer with soap dish, 1 1/4" pop-up waste
lavabo monocommande avec porte savon, vidage 1 1/4"

IF 44M176 CR

monocomando lavabo, scarico 1 1/4"
single-lever basin mixer, 1 1/4" pop-up waste
lavabo monocommande, vidage 1 1/4"

IF 44M176/S CR

monocomando lavabo, senza scarico
single-lever basin mixer, without waste
lavabo monocommande, sans vidage

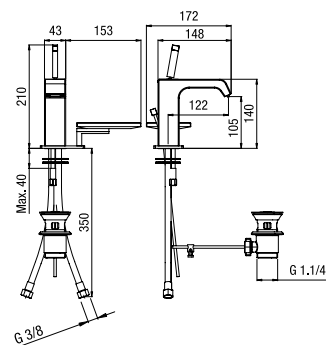

IF 44M202 CR

monocomando bidet con portasapone, scarico 1 1/4"
single-lever bidet mixer with soap dish, 1 1/4" pop-up waste
bidet monocommande avec porte savon, vidage 1 1/4"

IF 44M201 CR

monocomando bidet, scarico 1 1/4"
single-lever bidet mixer, 1 1/4" pop-up waste
bidet monocommande, vidage 1 1/4"

IF 44M201/S CR

monocomando bidet, senza scarico
single-lever bidet mixer, without waste
bidet monocommande, sans vidage

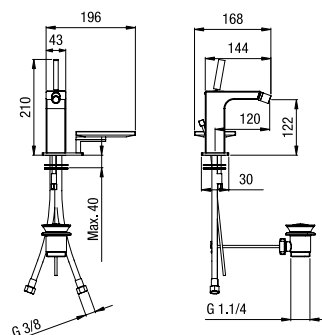

size **M**

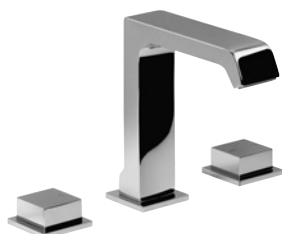

IF 76191 CR

batteria lavabo tre fori, senza scarico
three holes basin mixer, without waste
mélangeur lavabo trois trous, sans vidage



SC 010 CR

scarico click-clack
waste click-clack
vidage click-clack

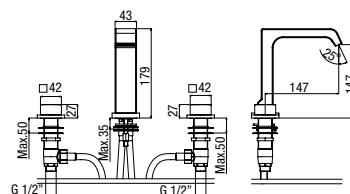

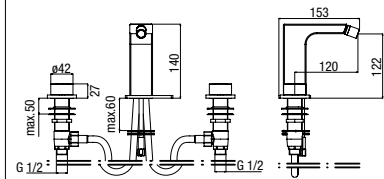

IF 76221 CR

batteria bidet tre fori, senza scarico
three holes bidet mixer, without waste
 mélangeur bidet trois trous, sans vidage



SC 010 CR

scarico click-clack
waste click-clack
 vidage click-clack

COLONNE DOCCIA SHOWER COLUMNS COLONNES DE DOUCHE

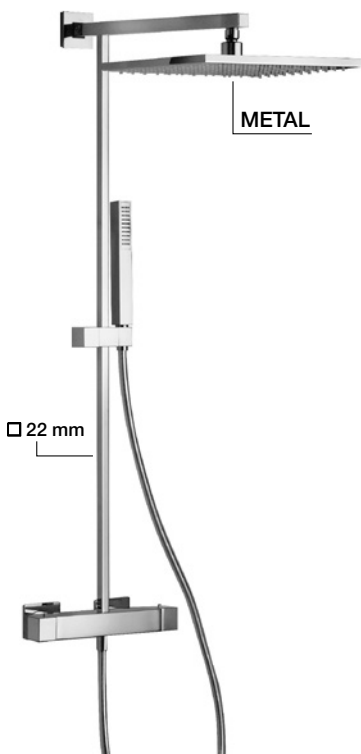

thermostatic

IF 44MSM2151 CR

colonna doccia termostatica,
 - deviazione integrata,
 - soffione 300x300 mm. **METAL**,
 - doccia monogetto
thermostatic shower column,
 - *integrated diverter,*
 - *300x300 mm. shower head METAL,*
 - *one spray handset*
 colonne de douche thermostatique,
 - inverseur intégré,
 - pomme de douche 300x300 mm. **METAL**,
 - douchette monojet

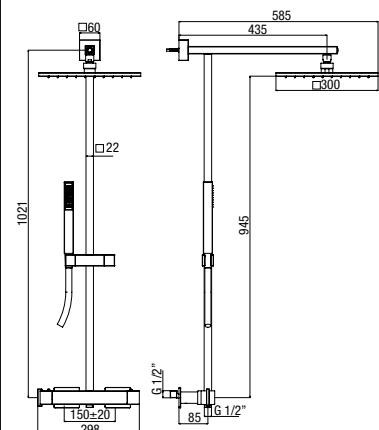

SOLUZIONI ESTERNO DOCCIA / VASCA SHOWER / BATH EXPOSED SOLUTIONS SOLUTIONS APPARENTES DOUCHE / BAIN



thermostatic

IF 44M156 CR

termostatico doccia esterno con portasapone
exposed thermostatic shower mixer with soap dish
 douche thermostatique apparent avec porte savon

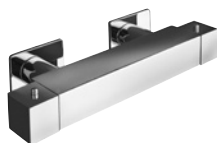

IF 44M155 CR

termostatico doccia esterno
exposed thermostatic shower mixer
 douche thermostatique apparent

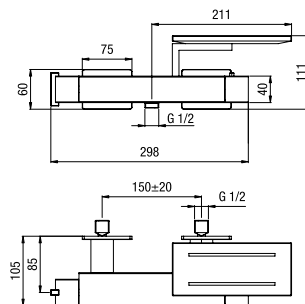

thermostatic

IF 44M107 CR

termostatico vasca esterno con portasapone
exposed thermostatic bath shower mixer with soap dish
 bain douche thermostatique apparent avec porte savon



IF 44M106 CR

termostatico vasca esterno
exposed thermostatic bath shower mixer
 bain douche thermostatique apparent

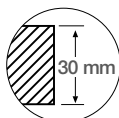
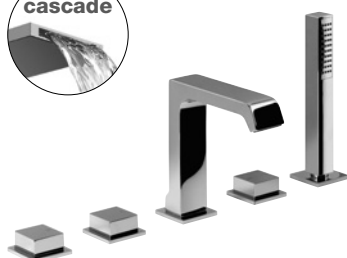
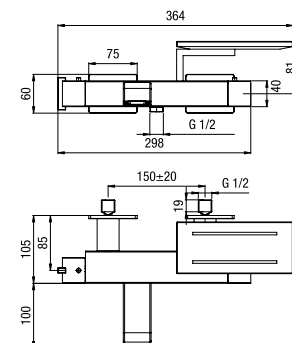

massimo spessore di fissaggio
maximum fixing thickness
 épaisseur maximum de fixation

IF PX21D30237 CR

rubinetteria tradizionale bordo vasca, deviatore meccanico,
 bocca di erogazione a cascata e doccia
deck mounted bath mixer, mechanical diverter,
cascade spout and handset
 mélangeur bain douche sur gorge, inverseur mécanique,
 bec cascade et douchette

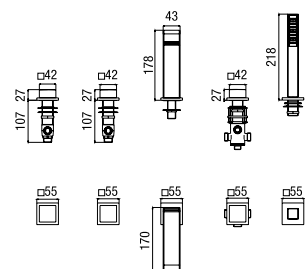

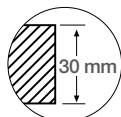

massimo spessore di fissaggio
maximum fixing thickness
 épaisseur maximum de fixation

IF PX21D337 CR

rubinetteria tradizionale bordo vasca,
 deviatore meccanico, e doccia
*deck mounted bath mixer,
 mechanical diverter, and handset*
 mélangeur bain douche sur gorge,
 inverseur mécanique, et douchette

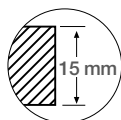
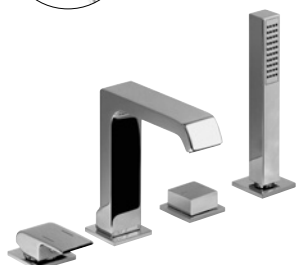
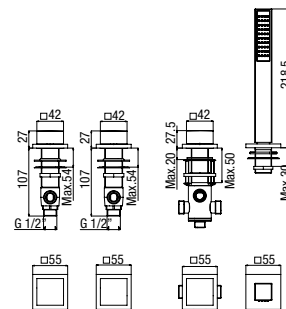

massimo spessore di fissaggio
maximum fixing thickness
 épaisseur maximum de fixation

IF M23D30237 CR

monocomando bordo vasca, deviatore meccanico,
 bocca di erogazione a cascata e doccia
*deck mounted single lever bath mixer, mechanical diverter,
 cascade spout and handset*
 bain douche monocommande sur gorge, inverseur mécanique,
 bec cascade et douchette

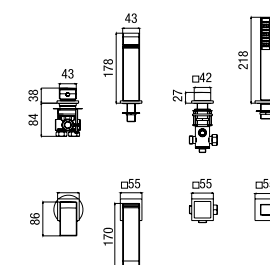

SOLUZIONI INCASSO DOCCIA / VASCA SHOWER / BATH CONCEALED SOLUTIONS SOLUTIONS ENCASTRÉES DOUCHE / BAIN

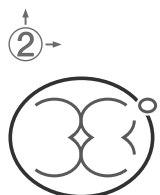

thermostatic

IF 44M163 CR

termostatico doccia incasso
con deviatore ceramico **due uscite** e regolazione portata
*concealed thermostatic shower valve
with **two outlets** ceramic diverter and stop*
douche thermostatique encastré
avec sélecteur céramique **deux sorties** et réglage débit

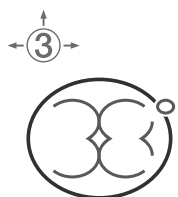
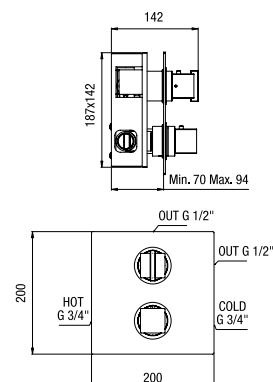
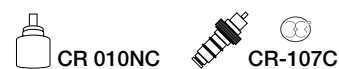

thermostatic

IF 44169 CR

termostatico doccia incasso
con deviatore ceramico **tre uscite** e regolazione portata
*concealed thermostatic shower valve
with **three outlets** ceramic diverter/flow control*
douche thermostatique encastré
avec sélecteur céramique **trois sorties** et réglage débit

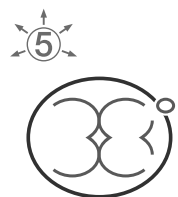
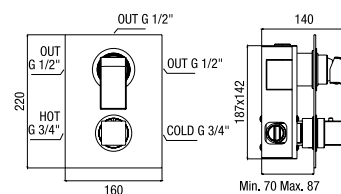

thermostatic

IF 44168 CR

termostatico doccia incasso
con deviatore ceramico **cinque uscite** e regolazione portata
*concealed thermostatic shower valve
with **five outlets** ceramic diverter/flow control*
douche thermostatique encastré
avec sélecteur céramique **cinq sorties** et réglage débit

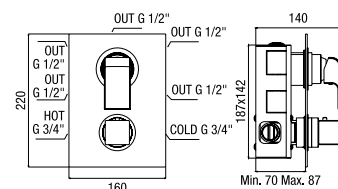

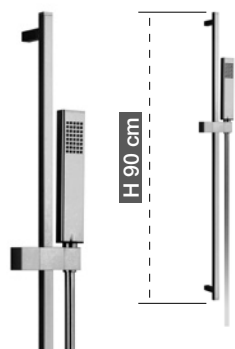

H 90 cm

KI 072 CR

kit saliscendi, asta 90 cm., doccia monogetto anticalcare, flessibile flexeco PVC 150 cm.

slide rail kit, 90 cm. tube, one spray anti-scale handset, flexeco PVC shower hose 150 cm.

kit barre de douche, barre 90 cm., douchette monojet anticalcaire, flexible flexeco PVC 150 cm.

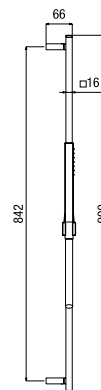

IF 002 CR

kit portasapone doccia e vasca

soap dish set for shower and bath shower

kit porte savon douche et bain douche

IF 004 CR

kit portasapone lavabo e bidet

soap dish set for basin and bidet

kit porte savon lavabo et bidet

